

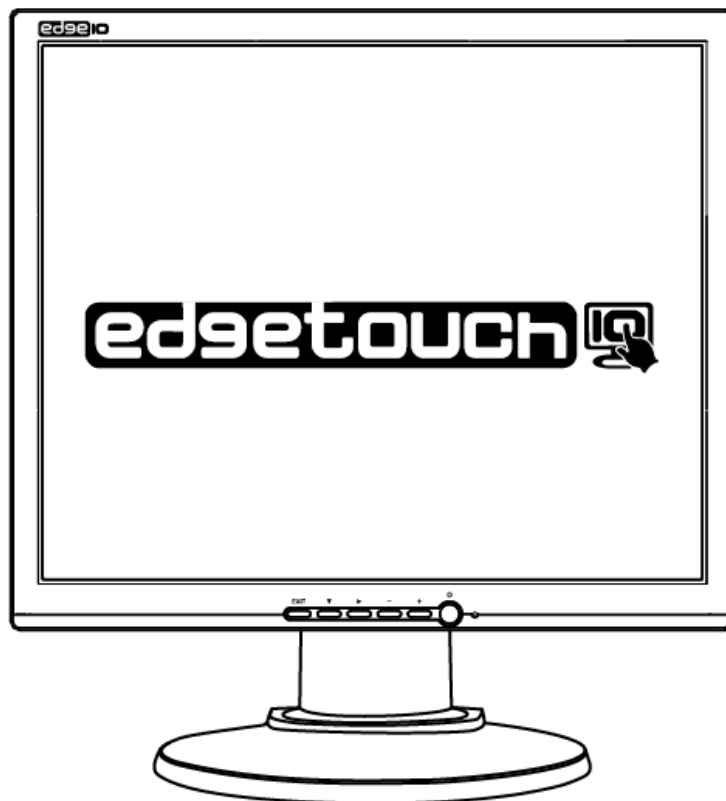

Advanced Display Systems



The display comes with a three year on site warranty.

To activate your warranty please register your display at

<http://www.edge10.com> by clicking on the help & support link.

LCD Display

Table of Contents

Introduction

Product Description.....	2
Package Contents.....	2
Product Features and Benefits.....	2

Recommended Use

Working Environment.....	3
Cleaning.....	3

Control Function

Control Button Front View.....	4
OSD Control.....	5
OSD Icon Overview.....	6

Inputs Diagram.....8

Display Angle.....9

Installing TouchKit Driver.....11

Product Specification.....12

Display Modes13

Important Notice.....14

Introduction

Product Description

Congratulations on your purchase of this innovative monitor. Your LCD monitor incorporates high quality display into a small lightweight module. It is environment friendly because of its zero radiation emission and low power consumption. This LCD monitor utilizes 17" color active matrix thin-film transistor (TFT) liquid crystal display to provide superior display performance. A maximum resolution of SXGA 1280x1024 along with the plug & play compatibility, audio system and OSD (On Screen Display) controls, enhance the LCD monitor's performance.

Package Contents

The following items should be included within the box:

- 17" TFT-LCD monitor
- 15pin D-sub signal cable
- Power cord
- Audio cable
- USB cable
- User manual
- Warranty card
- CD (include the Touch Utility User Guide and the driver-software)

Product Features and Benefits

- ★ **Fast display response** provides smooth full-motion images in high speed gaming and video applications.
- ★ **High resolution, brightness level and contrast ratio** enhance your visual experience.
- ★ **On-screen display user controls** deliver easy and precise adjustments to the visual quality.
- ★ **VESA mounting compliant** allows you to free up even more desktop space and gain more aesthetic appeal.
- ★ **Built-in speaker** enhances your multimedia applications with stereo sound.
- ★ **Thin-Frame design** not only frees up valuable space but adds a sleek, eye-pleasing appeal to your desktop.
- ★ **Compatibility** with IBM VGA, VESA, and Macintosh capabilities.

Recommended Use

Working Environment

- ※ Place the monitor on a flat and level surface.
- ※ Place the monitor in a well-ventilated place.
- ※ Keep the monitor away from:
overly hot, cold or humid places, direct sunlight, dusty surroundings, and equipments that generate strong magnetic fields.
- ※ For optimal performance, allow 1~2 minutes for warm-up.
- ※ Adjust the monitor height so that the top of the screen is at or slightly below eye level. Your eyes should look slightly downward when viewing the middle of the screen.
- ※ Position your monitor no closer than 16 inches and no further away than 28 inches from your eyes. The optimal distance is 20 inches.
- ※ Rest your eyes periodically by focusing on an object at least 20 feet away. Blink often.
- ※ Position the monitor at a 90° angle to windows and other light sources to minimize glare and reflections. Adjust the monitor tilt so that ceiling lights do not reflect on your screen.
- ※ If reflected light makes it hard for you to see your screen, use an anti-glare filter.
- ※ Clean the LCD monitor surface with a lint-free, non-abrasive cloth. Avoid using any cleaning solution or glass cleaner.
- ※ Adjust the monitor's brightness and contrast controls to enhance readability.
- ※ Position whatever you are looking at most of the time (the screen or reference material) directly in front of you to minimize turning your head while you are typing.
- ※ Avoid displaying fixed patterns on the monitor for long periods of time to avoid after image effects.

Cleaning

- ※ Gently wipe the LCD screen with a soft, clean, lint-free cloth.
This removes dust and other particles that can scratch the screen. Do not apply pressure to the screen surface when wiping it clean. Do not pour or spray any liquid directly onto the screen or case of the monitor. Chemical cleaners have been reported to damage the monitor.

Control Function

Control Button Front View

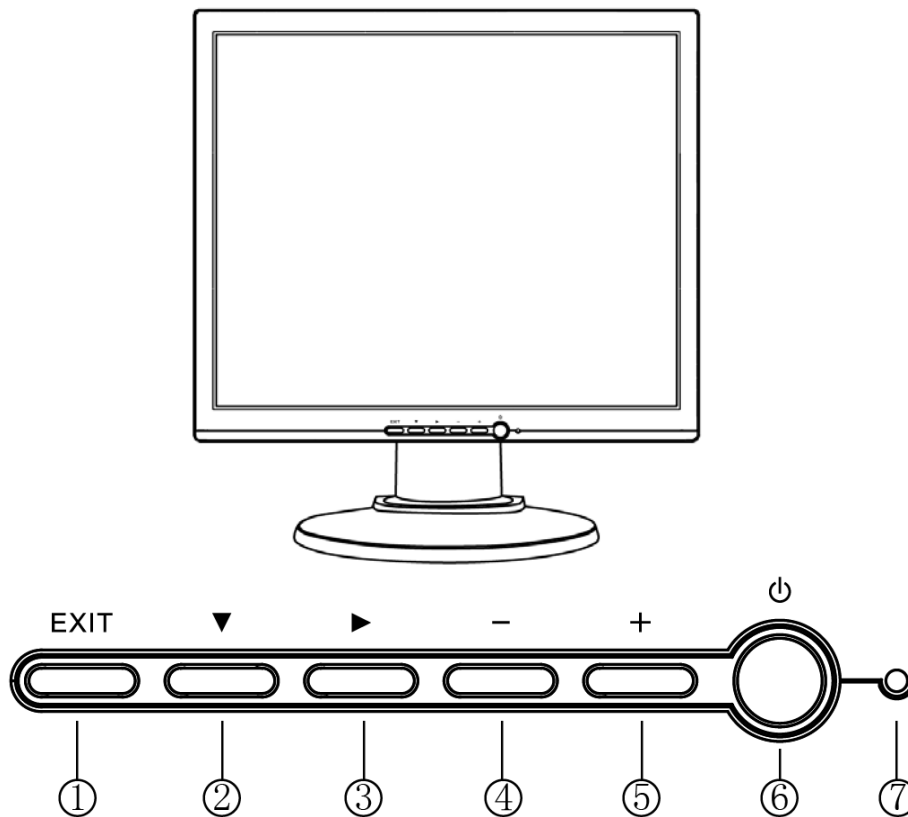

1. Exit: Exit the OSD (On Screen Display);
2. Channel“▼”: Press to bring up the On Screen Display and select main menu items.
3. Channel “►”: Press to bring up the On Screen Display and select sub menu items.
4. Decrease “-”: Adjust sub-setting bars i.e. CONTRAST, BRIGHINESS, etc. to decrease setting values of the OSD;
5. Increase “+”: Adjust setting bars i.e. CONTRAST, BRIGHINESS, etc. to increase setting values of the OSD.
6. Power switch: Turns power on/off
7. Power LED: Indicates different status when unit operates indifferent modes

The hot key

1. “EXIT” ----> Auto turning
2. “-” ----> Audio mute on/off
3. “+” ----> Values turning

OSD Control

OSD function allows the user to easily adjust the display to the desired quality.

Structure of OSD

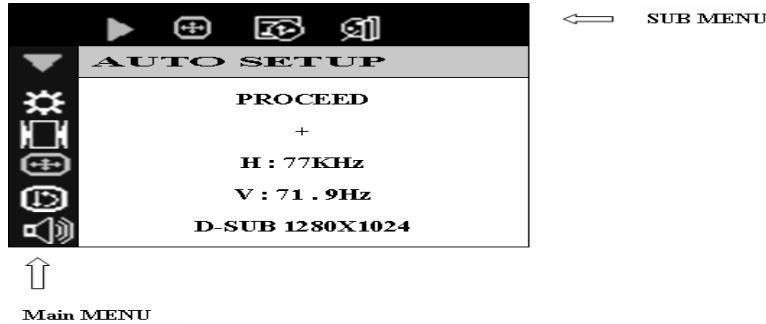

Operating Procedure

1. Power on the LCD monitor.
2. Press “▼” or “▶” to pop up OSD menu.
3. Press “▼” to select main menu item.
4. Press “▶” to select sub menu item.
5. Press “+” and “-” buttons to adjust.
6. Press the EXIT button when finishes adjusting.

- The Adjustment of Monitor’s Screen Display
There are two ways to adjust the monitor’s screen, i.e. auto adjustment and manual adjustment.

■ Auto adjustment



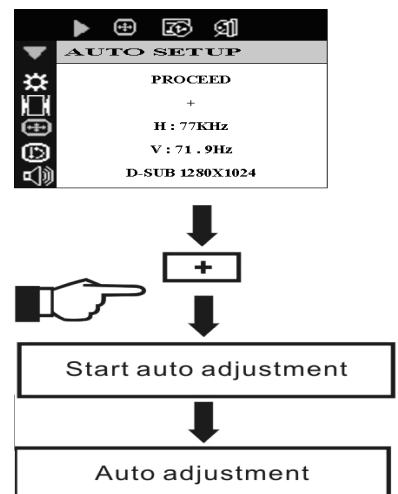

















1. Power ON the LCD monitor and computer.
2. Select “AUTO SETUP” of OSD screens by pressing the “▼” button to “AUTO SETUP”.
3. Press “+” button while displaying “AUTO SETUP” screen.
4. The auto adjustment is started. “AUTO SETUP” will be displayed during auto adjustment. It takes about 5 seconds to finish adjustment.



■ Manual adjustment

- a) Power ON the LCD monitor and computer.
- b) Adjust according to the aforementioned “Operating Procedure” and “Menu Table” to adjust the screen to your favorable screen display.

OSD Icon Overview

Main Menu	Sub Menu	Function Name	Function
		BRIGHTNESS	Adjusts the level of brightness and darkness
		CONTRAST	Adjusts the RGB color pattern set of the contrast
		EXIT	Tune off OSD window
		CLOCK	Adjusts the number of pixels from source video
		CLOCK PHASE	Adjusts the phase relative to video H-sync signal
		H POSITION	Moves the screen horizontally (left/right)
		V POSITION	Moves the screen vertically (up/down)
		AUTO SETUP	To auto adjust press the “+” button
		OSD TIME OUT	Auto tune off OSD window timer
		ALL RESET	Return to factory preset value
		OSD POSITION	Changes the OSD position
		DISPLAY MODE	“-” Represents the TEXT mode “+” Represents the GRAPHIC mode
		LANGUAGE	Press “+” and “-” to choose OSD language
		COLOR	STANDARD: Factory preset color select (9300K, 7500K, 6500K(default), 5400K, 4200K) CUSTOM: Preferred color is adjusted
		VOLUME	Adjust the volume of built-in speaker
		MUTE	Disable or enable sound

NO SIGNAL INPUT

1. If this warning appears, please check the connector. If it is bent or damaged, the signal cable may be affected.
2. If the monitor is in “sleep” mode to save power, please move the mouse or press any key to “wake” it and return to working mode.
3. Please check relevant diagrams, and make sure the monitor has been properly configured.
4. Please check the signal cable. If the type is incorrect, please use the cable that came with the monitor.

OUT OF RANGE

H: 35 KHz

V: 86.8Hz

This warning indicates that the input signal frequency does not match those supported by this monitor. For this model, horizontal frequency must be in the range of 30 ~ 80 KHz and vertical frequency in the range of 55~75Hz. Please make sure your input signal is within these ranges.

Inputs Diagram

Inputs

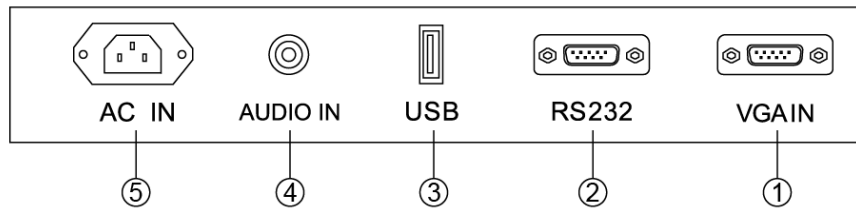
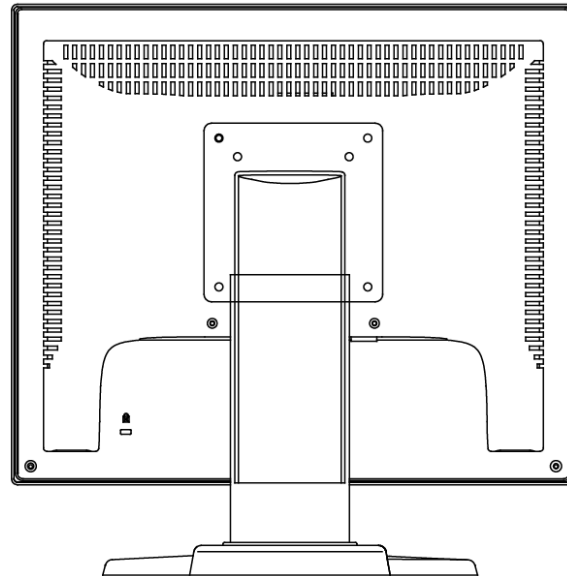

1. **VGA IN:** This is to be connected to the D-Sub 15 pin signal connector.
2. **RS232:** This can be connected for touch panel.
3. **USB:** This can be connected for touch panel.
4. **AUDIO IN:** The audio jack is connecting to audio source.
5. **AC POWER INPUT:** AC inlet for 100-240V power system.

Display Angle

Tilting for viewing clarity or personal preferences

1. you can tile the LCD forward (Down to 4 degrees) or backward (up to 20 degrees).

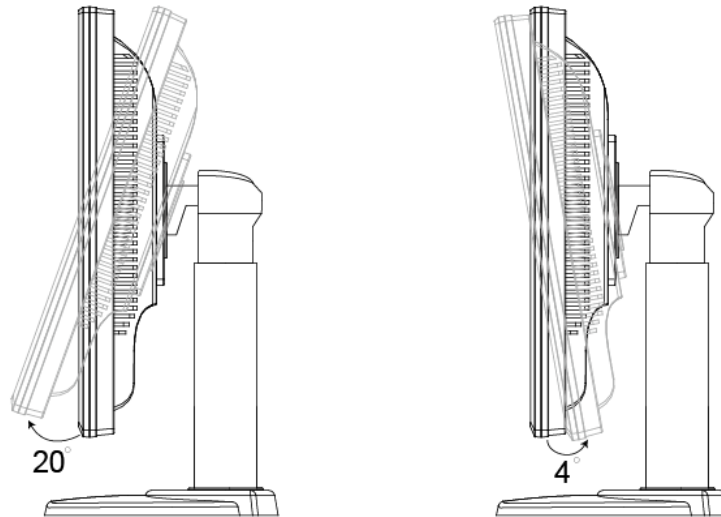

2. You can adjust the stand of the LCD to turn upward for 110mm height.

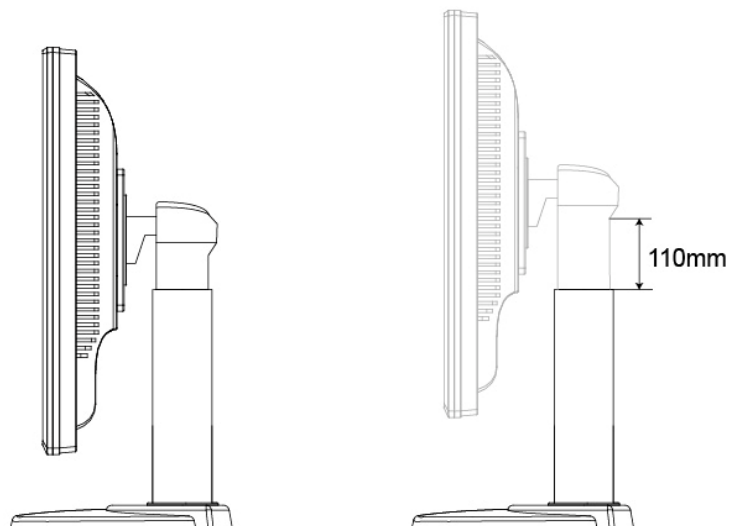

3. You can revolve the LCD to clockwise or inverse from 0° to 90° .

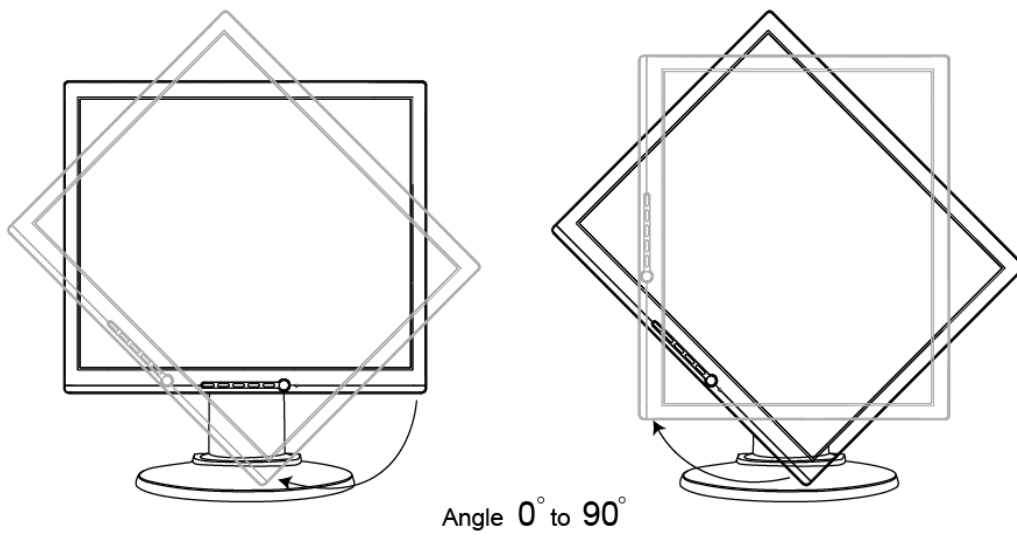

3. You can title the left of LCD backward from 0° to 45° , the same as the right of LCD.

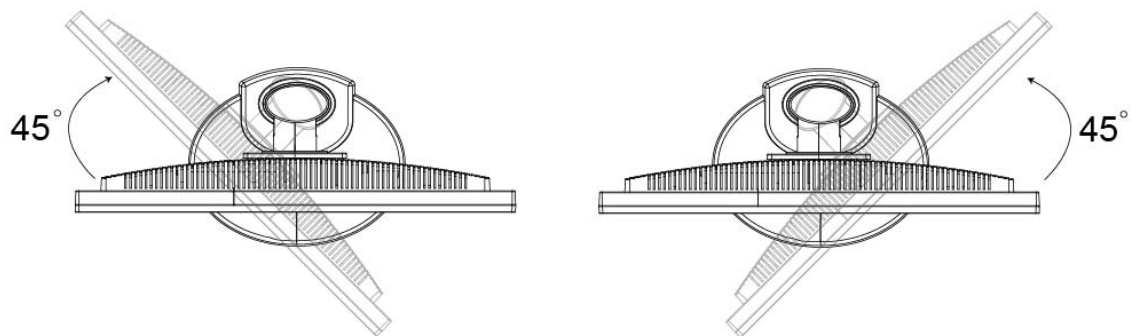

Installing TouchKit Driver

TouchKit is software, which contains drivers of the touch panel controllers for the specified communication connectors, RS232 and USB, and another utility.

The touch panel driver emulates mouse left and right button function and supports operation systems including Microsoft Windows 95/98/ME/NT4 /2000/XP/XP Tablet PC Edition, Windows CE 2.12/3.0/NET, Linux, iMac and DOS.

Configuration support

The calibration and draw test of touch panel are done by this utility. Besides, users can add or remove for new RS-232 touch panel device.

Follow these steps to install TouchKit for windows XP

1. Put the TouchKit CD to CD-ROM.
2. Open Win2000_XP directory.
3. Double click the Setup.exe, then windows starts to run the installation program.

If using other PC operation systems, please download the corrective driver from Website: <http://www.eturbotouch.com/home.asp>

Product Specification

Display Type	17" active matrix TFT LCD panel
Pixel pitch	0.264(H)x0.264(V)mm
Contrast Ratio	500:1
Viewing Angle	L/R +75°~-75°
	U/D +70°~-60°
Operation Feature	
H Frequency Input Range	31.5KHz-80KHz
V Frequency Input Range	56Hz-75Hz
Video Frequency	135MHz
Display Colors	16.2M
Resolution	SXGA 1280x1024@75Hz
Brightness	>140 cd/m2
Response Time	5ms
Input Connector	
PC	Analog:15-pin-D-SUB
Audio System	Phone Jack(2x2W Built-in Speakers)
Touch Screen	5wires resistive touch, RS232/USB
Users Control	
Front Panel Controls	Auto Adjust, Menu, Up, Down, Soft Power
OSD Controls	Brightness, Contrast, Auto Adjust, Phase, Clock, H-Position, V-Position, Color Temperature, Language, OSD H/V Position, Reset
Power	
Power Saving	VESA DPMS Standard
Power Consumption	40W(Max)
Regulation	
Safety/EMI	TUV,CE, FCC(DOC)
Dimension and Weight	
Dimension(W x H x D)	403(H)*378(w)*210(D)mm
Weight	N/M:6.7kg G/W:7.7kg

Display Modes

Display Mode		Dot Clock (MHz)	Horizontal Frequency (KHz)	Vertical Frequency (Hz)	Sync Polarity (H/V)	Operating Mode (Analog)
VGA	640 x 350	25.18	31.47	70.08	+/-	Analog
VGA	640 x 480	25.18	31.47	59.94	-/-	Analog
VESA	640 x 480	31.50	37.86	72.81	-/-	Analog
VESA	640 x 480	31.50	37.50	75.00	-/-	Analog
VGA	720 x 400	28.32	31.47	70.09	-/+	Analog
VESA	800 x 600	36.00	35.16	56.25	+/+	Analog
SVGA	800 x 600	40.00	37.88	60.32	+/+	Analog
VESA	800 x 600	49.50	46.88	75.00	+/+	Analog
VESA	800 x 600	50.00	48.08	72.19	+/+	Analog
XGA	1024 x 768	65.00	48.36	60.00	-/-	Analog
VESA	1024 x 768	75.00	56.48	70.07	-/-	Analog
VESA	1024x 768	78.75	60.02	75.03	+/+	Analog
VESA	1280 x 960	108.0	60.00	60.0	+/+	Analog
VESA	1280x1024	108.0	63.98	60.02	+/+	Analog
VESA	1280x 1024	135.0	79.98	75.03	+/+	Analog
Macintosh	640 x 480	30.24	35.00	66.67	-/-	Analog
Macintosh	832 x 624	57.28	49.73	74.55	-/-	Analog
VESA	1152 x 864	108	67.50	75.0	+/+	Analog
Macintosh	1152 x 870	100	68.68	75.06	-/-	Analog
SUN	1152 x 900	94.5	61.8	66.0	-/-	Analog
	1280x1024	118.13	71.6	67.1	-/-	Analog
	1280 x 960	108	62.5	62.5	+/+	Analog

Important Notice

All electrical and electronic products should be disposed of separately from the municipal waste stream via designated collection facilities appointed by the government or the local authorities.

This crossed-out wheeled bin symbol on the product means the product is covered by the European Directive 2002/96/EC.

The correct disposal and separate collection of your old appliance will help prevent potential negative consequences for the environment and human health. It is a precondition for reuse and recycling of used electrical and electronic equipment.

For more detailed information about disposal of your old appliance, please contact your city office, waste disposal service or the shop where you purchased the product.

edgetouch 

www.edge10.com